

# MINI-BOX

## Aspiratori centrifughi in linea insonorizzati Slim-line acoustic cabinet fans



**UE 1253/2014**

### Conformi

alla Direttiva ErP e al Regolamento UE 1253/2014 (Unità di ventilazione)

### Comply

with ErP Directive and EU Regulation 1253/2014 (Ventilation unit)

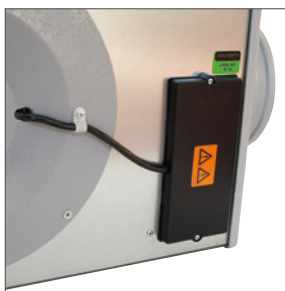

Morsettiera integrata (fino a modello 150)  
Integrated terminal box (up to model 150)

### DESCRIZIONE

La serie MINI-BOX consiste in aspiratori centrifughi in linea caratterizzati da un corpo isolato acusticamente e con bocche circolari (diametro da 100mm a 315mm) per un facile collegamento ai sistemi canalizzati circolari.

Le caratteristiche principali di questa gamma sono: la modularità, l'elevata silenziosità, gli ingombri limitati e facilità d'installazione (grazie alla staffa di fissaggio inclusa) e manutenzione (grazie all'accessibilità del gruppo motore).

La forma particolare di questi ventilatori li rende ideali per l'installazione all'interno di controsoffittature in abitazioni, uffici, locali pubblici...

Sono adatti a convogliare aria pulita ad una temperatura da -10°C a +60°C.

### COSTRUZIONE

- Corpo in lamiera di acciaio zincato coibentato internamente con materiale fonoassorbente (Sp. 10mm).
- Staffa di fissaggio.
- Girante a pale rovesce ad alto rendimento e basso livello sonoro.
- Scatola morsettiera IP 55.

### MOTORE

Motore elettrico monofase, IP44, classe F, termoprotetto, idoneo ad un funzionamento in regolazione di velocità (utilizzando i regolatori indicati in questo catalogo).

### ACCESSORI

- Elementi riscaldanti a resistenza (BE).
- Serrande.
- Collari di fissaggio.
- Reti di protezione.

### DESCRIPTION

The MINI-BOX series consists of centrifugal in-line fans, with acoustically insulated casing and with round spigot (diameter from 100mm to 315mm) for easy connection to round duct system.

Main features of this range are: modularity, extremely quiet operation, reduced dimensions and ease of installation (thanks to included support bracket) and maintenance (thanks to accessible motor/impeller).

The ultra-slim shape of these fans make them ideal for false ceiling installation in houses, offices, public premises...

They are suitable to convey clean air with a temperature range from -10°C to +60°C.

### CONSTRUCTION

- Casing in galvanized steel sheet, lined with acoustic insulation (thickness 10 mm).
- Fitting bracket
- Backward curved impeller with high efficiency and low noise level.
- Outer terminal box IP55.

### MOTOR

Single-phase electric motor, IP44, class F, with thermal protection, suitable for speed control (using the suitable speed regulators shown in this catalogue).

### ACCESSORIES

- Electric duct heaters BE.
- Backdraught shutters.
- Duct clamps.
- Protection guards.

# PRESTAZIONI | PERFORMANCE

# MINI-BOX

Le prestazioni aerauliche sono rilevate in conformità alla norma EN ISO 5801/AMCA 210 con densità dell'aria standard avente peso specifico 1,2 Kg/m<sup>3</sup>. Alimentazione 230V/1Ph/50Hz o 400V/3Ph/50Hz. In conformità al regolamento UE 1253/2014, le Unità di Ventilazione a singolo flusso devono essere abbinate al momento della messa in servizio, a un azionamento a velocità multiple o kit local o equivalente.  
Air performances measured according to EN ISO 5801 / AMCA 210 standard with air density with 1.2 kg/m<sup>3</sup> specific weight. Power supply 230V/1Ph/50Hz or 400V/3Ph/50Hz. In compliance with EU Regulation 1253/2014, the single flow Ventilation Units must be connected to a multiple speed regulation (local demand controller or equivalent) when put into service.

**Lp** Livello di pressione sonora rilevato in condizioni di campo libero, propagazione sferica, categoria di misura D a norma EN ISO 13349, nel punto di massimo rendimento, alla distanza di 1,5 metri dal lato aspirazione e si presenta solo per fini comparativi.  
Sound pressure levels measured in free field conditions, propagation hemispherical, measurement category C in accordance with EN ISO 13349, at the maximum efficiency point, at a distance of 1,5 meters from inlet side (for comparative purposes only).

**Lw** Livello di potenza sonora ottenuto secondo norma ISO 3746. Tolleranza +/- 3 dB(A). Sound power levels obtained according to ISO 3746. Tolerance +/- 3 dB(A).

## MINI-BOX 100

Code	Tipo Type	Modello Model	U	rpm	Pm (kW)	In (A)	IP/CL
1MB0104	MINI-BOX	100	M	1990	0,05	0,23	44/F

### LIVELLI SONORI | SOUND LEVELS dB(A)

Tipo Type	Modello Model	Lp dB (A) TOT.	Lw dB (A) TOT.
MINI-BOX	100	44	56

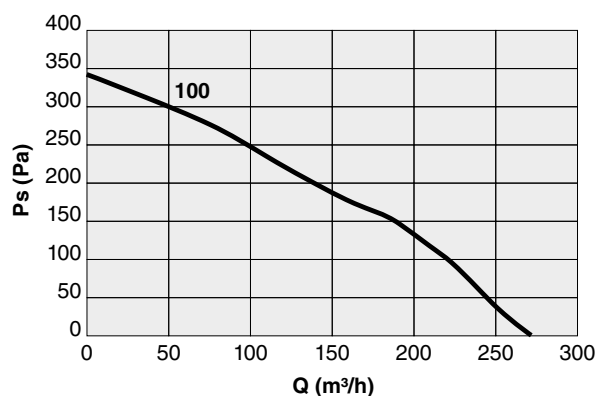

## MINI-BOX 125

Code	Tipo Type	Modello Model	U	rpm	Pm (kW)	In (A)	IP/CL
1MB0133	MINI-BOX	125	M	1700	0,05	0,23	44/F

### LIVELLI SONORI | SOUND LEVELS dB(A)

Tipo Type	Modello Model	Lp dB (A) TOT.	Lw dB (A) TOT.
MINI-BOX	125	45	56

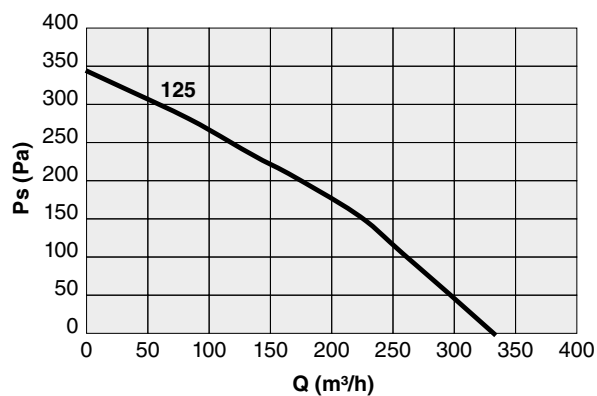

## MINI-BOX 150

Code	Tipo Type	Modello Model	U	rpm	Pm (kW)	In (A)	IP/CL
1MB0157	MINI-BOX	125	M	2530	0,05	0,23	44/F

### LIVELLI SONORI | SOUND LEVELS dB(A)

Tipo Type	Modello Model	Lp dB (A) TOT.	Lw dB (A) TOT.
MINI-BOX	150	47	59

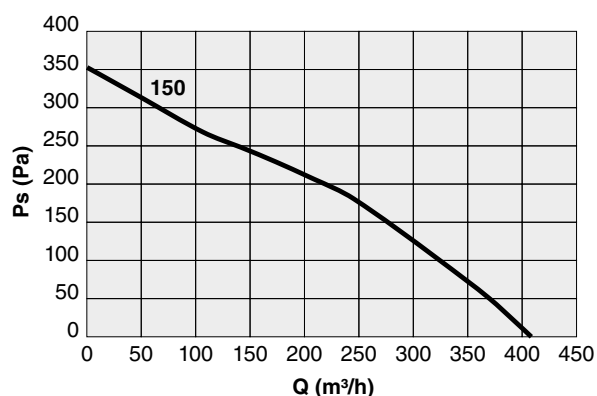

sbz.  
**1.6**

MINI-BOX aspiratori | fans

## MINI-BOX 200

Code	Tipo Type	Modello Model	U	rpm	Pm (kW)	In (A)	IP/CL
1MB2010	MINI-BOX	200	M	2550	0,11	0,49	44/F

### LIVELLI SONORI | SOUND LEVELS dB(A)

Tipo Type	Modello Model	Lp dB (A) TOT.	Lw dB (A) TOT.
MINI-BOX	200	42	54

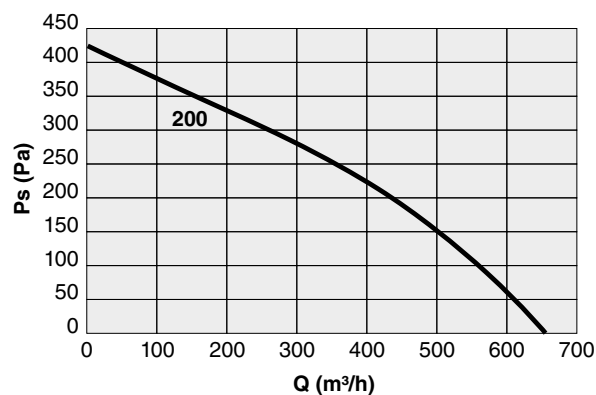

## MINI-BOX 250

Code	Tipo Type	Modello Model	U	rpm	Pm (kW)	In (A)	IP/CL
1MB2505	MINI-BOX	250	M	2550	0,15	0,65	44/F

### LIVELLI SONORI | SOUND LEVELS dB(A)

Tipo Type	Modello Model	Lp dB (A) TOT.	Lw dB (A) TOT.
MINI-BOX	250	52	63

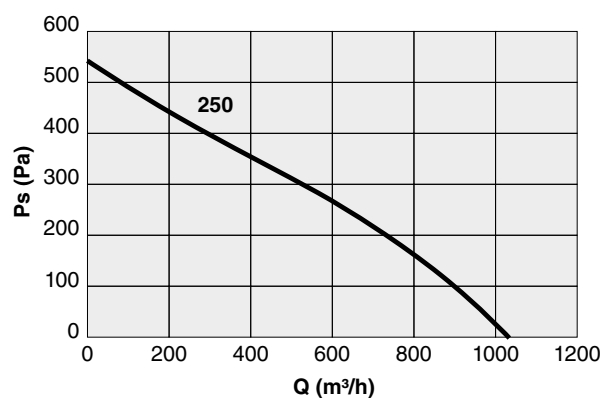

## MINI-BOX 315

Code	Tipo Type	Modello Model	U	rpm	Pm (kW)	In (A)	IP/CL
1MB3155	MINI-BOX	315	M	2630	0,26	1,14	44/F

### LIVELLI SONORI | SOUND LEVELS dB(A)

Tipo Type	Modello Model	Lp dB (A) TOT.	Lw dB (A) TOT.
MINI-BOX	315	51	63

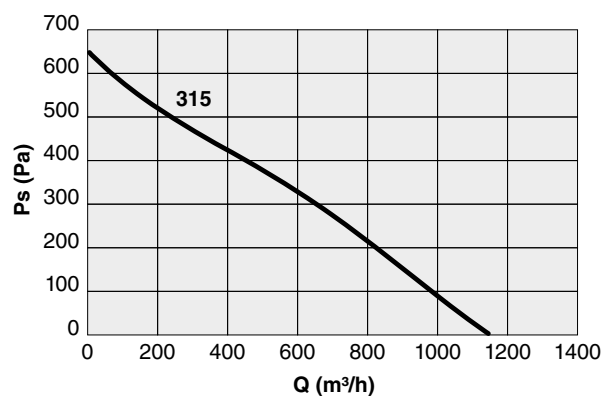

## MINI-BOX 100 - 125 - 150

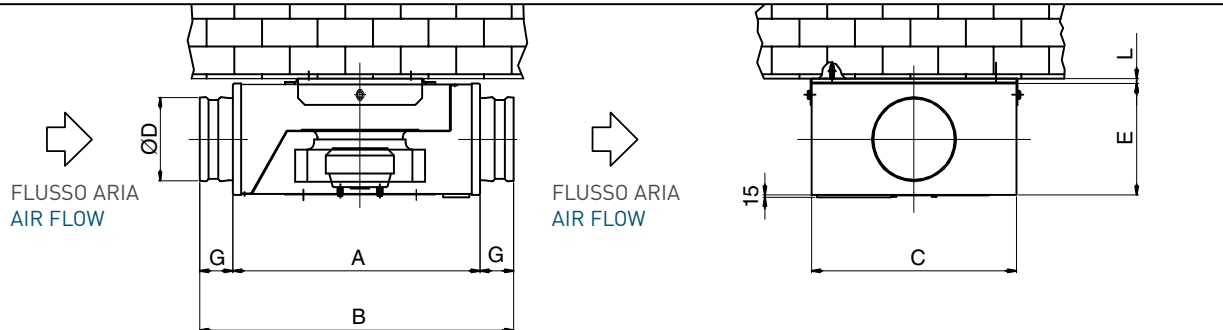

## MINI-BOX 200 - 250 - 315

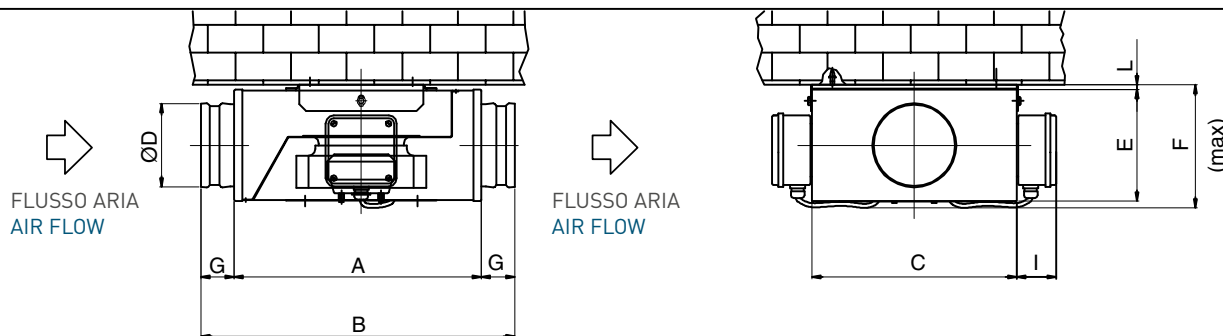

## MINI-BOX

Tipo   Type	A	B	C	D	E	F	G	I	L	kg
<b>MINI-BOX 100</b>	433	510	307	99	167	-	40	-	10	7,8
<b>MINI-BOX 125</b>	433	510	307	124	167	-	40	-	10	7,8
<b>MINI-BOX 150</b>	433	510	307	150	187	-	40	-	10	8,2
<b>MINI-BOX 200</b>	503	580	373	198	233	260	40	60	10	12,8
<b>MINI-BOX 250</b>	503	610	373	247	283	310	55	60	10	14,8
<b>MINI-BOX 315</b>	503	610	423	314	343	370	55	60	10	17,4

Pesi indicativi | Indicative weights



## BE | ELEMENTI RISCALDANTI A RESISTENZA | ELECTRIC HEATERS

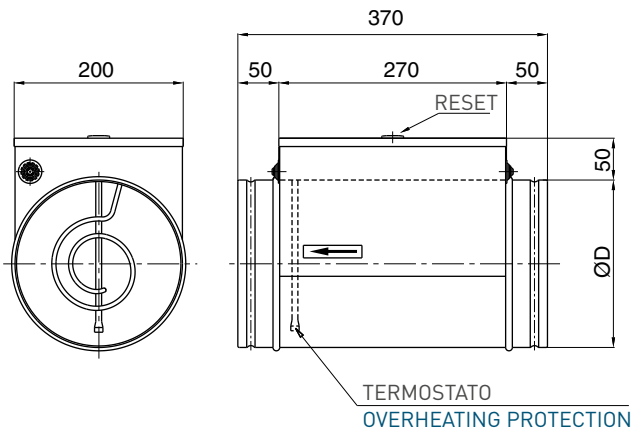

Code	Tipo   Type	ØD mm	Q min m³/h	U	P kW	I nom A
1BA2100	BE 100-0,6-1F	100	40	1-230V-50Hz	0,6	2,8
1BA2125	BE 125-0,6-1F	125	70	1-230V-50Hz	0,6	2,8
1BA2126	BE 125-1,2-1F	125	70	1-230V-50Hz	1,2	5,5
1BA2160	BE 160-1,2-1F	160	110	1-230V-50Hz	1,2	5,5
1BA2161	BE 160-2,0-1F	160	110	1-230V-50Hz	2,0	9,1
1BA2200	BE 200-2,0-1F	200	170	1-230V-50Hz	2,0	9,1
1BA2201	BE 200-6,0-3F	200	170	3-400V-50Hz	6,0	8,7
1BA2250	BE 250-2,4-1F	250	270	1-230V-50Hz	2,4	10,9
1BA2251	BE 250-6,0-3F	250	270	3-400V-50Hz	6,0	8,7
1BA2315	BE 315-6,0-3F	315	450	3-400V-50Hz	6,0	8,7

Dimensioni in mm | Dimensions in mm

Incremento temperatura | Temperature increase

$$\Delta T [^{\circ}\text{C}] \approx \frac{P [\text{kW}]}{Q [\text{m}^3/\text{s}] \cdot \rho [\text{kg}/\text{m}^3]}$$

## 2SA | SERRANDA | SHUTTER

Serranda a farfalla "di non ritorno", realizzata in lamiera zincata con guarnizione sulla chiusura delle alette, per una maggiore tenuta e minore rumorosità.

Back draught throttle shutter in galvanized steel sheet with gasket on the closing of the fins, for greater sealing and less noise transmission.



Code	Tipo   Type
2SA1000	MINIBOX 100
2SA1250	MINIBOX 125
2SA1500	MINIBOX 150
2SA1600	MINIBOX 160
2SA2000	MINIBOX 200
2SA2500	MINIBOX 250
2SA3150	MINIBOX 315

Dimensioni in mm | Dimensions in mm

## 2FA | COLLARE DI FISSAGGIO ANTIVIBRANTE | DUCT CLAMPS

Collare realizzato in lamiera zincata, rivestito internamente con poliuretano espanso. Necessario per collegare il ventilatore alla canalizzazione.

Duct clamp manufactured in galvanized steel sheet, inside lined with expanded polyurethane. Necessary to connect the fan to the duct.



Code	Tipo   Type
2FA1000	MINIBOX 100
2FA1250	MINIBOX 125
2FA1500	MINIBOX 150
2FA1600	MINIBOX 160
2FA2000	MINIBOX 200
2FA2500	MINIBOX 250
2FA3150	MINIBOX 315

Dimensioni in mm | Dimensions in mm

## 2SR | RETE DI PROTEZIONE | PROTECTION GUARD

Set composto da una rete di protezione realizzata in tondino d'acciaio protetto contro la corrosione e minuteria per il fissaggio sulla bocca tonda del ventilatore.

ATTENZIONE: questo accessorio si rende indispensabile se la bocca non è canalizzata o protetta in altro modo.

Set composed by protection guard manufactured in steel rod protected against the corrosion and screws for the fixing on the round side of the fan.

ATTENTION: this accessory is compulsory if the side of the fan is not ducted or protected in any other way.

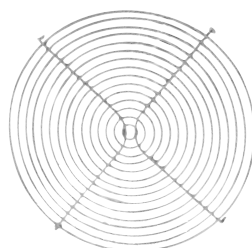

Code	Tipo   Type
2SR1000	MINIBOX 100
2SR1250	MINIBOX 125
2SR1500	MINIBOX 150
2SR1600	MINIBOX 160
2SR2000	MINIBOX 200
2SR2500	MINIBOX 250
2SR3150	MINIBOX 315

Dimensioni in mm | Dimensions in mm